

Edition

04/2023

Installation Manual

SIMATIC NET

Rugged Ethernet Switches

RUGGEDCOM RSG2300

<https://www.siemens.com/ruggedcom>

SIEMENS

SIMATIC NET

Rugged Ethernet Switches RUGGEDCOM RSG2300

Installation Manual

Preface	
Introduction	1
Installing the Device	2
Device Management	3
Communication Ports	4
Technical Specifications	5
Certification	6

Legal information

Warning notice system

This manual contains notices you have to observe in order to ensure your personal safety, as well as to prevent damage to property. The notices referring to your personal safety are highlighted in the manual by a safety alert symbol, notices referring only to property damage have no safety alert symbol. These notices shown below are graded according to the degree of danger.

 DANGER

indicates that death or severe personal injury will result if proper precautions are not taken.

 WARNING
--

indicates that death or severe personal injury may result if proper precautions are not taken.
--

 CAUTION
--

indicates that minor personal injury can result if proper precautions are not taken.
--

 NOTICE

indicates that property damage can result if proper precautions are not taken.
--

If more than one degree of danger is present, the warning notice representing the highest degree of danger will be used. A notice warning of injury to persons with a safety alert symbol may also include a warning relating to property damage.

Qualified personnel

The product/system described in this documentation may be operated only by **personnel qualified** for the specific task in accordance with the relevant documentation, in particular its warning notices and safety instructions. Qualified personnel are those who, based on their training and experience, are capable of identifying risks and avoiding potential hazards when working with these products/systems.

Proper use of Siemens products

Note the following:

 WARNING
--

Siemens products may only be used for the applications described in the catalog and in the relevant technical documentation. If products and components from other manufacturers are used, these must be recommended or approved by Siemens. Proper transport, storage, installation, assembly, commissioning, operation and maintenance are required to ensure that the products operate safely and without any problems. The permissible ambient conditions must be complied with. The information in the relevant documentation must be observed.
--

Trademarks

All names identified by ® are registered trademarks of Siemens Canada Ltd.. The remaining trademarks in this publication may be trademarks whose use by third parties for their own purposes could violate the rights of the owner.

Disclaimer of liability

We have reviewed the contents of this publication to ensure consistency with the hardware and software described. Since variance cannot be precluded entirely, we cannot guarantee full consistency. However, the information in this publication is reviewed regularly and any necessary corrections are included in subsequent editions.

Table of contents

Preface	v
Related Documents	v
SIMATIC NET Glossary	v
Accessing documentation	v
Registered trademarks	v
Warranty	vi
Training	vi
Customer support	vii
Contacting Siemens	vii
1 Introduction	1
1.1 Feature Highlights	1
1.2 Description	2
1.3 Required Tools and Materials	3
1.4 Decommissioning and disposal	3
1.5 Cabling Recommendations	4
1.5.1 Protection On Twisted-Pair Data Ports	4
1.5.2 Gigabit Ethernet 1000Base-TX Cabling Recommendations	5
1.5.3 Supported fiber optic cables	5
2 Installing the Device	7
2.1 General Procedure	8
2.2 Unpacking the device	8
2.3 Mounting the Device	8
2.3.1 Mounting the Device to a Rack	9
2.3.2 Mounting the Device on a DIN Rail	10
2.3.3 Mounting the Device to a Panel	11
2.4 Connecting the Failsafe Alarm Relay	12
2.5 Connecting Power	13
2.5.1 Connecting AC or DC Power	14
2.5.2 Wiring Examples	16
3 Device Management	19
3.1 Connecting to the Device	19
3.2 Configuring the Device	20
4 Communication Ports	21
4.1 Copper Ethernet Ports	22
4.2 Fiber Optic Ethernet Ports	23
4.3 SFP Transceivers	24

4.4	GBIC Optic Ethernet Ports	24
4.4.1	Installing a GBIC Optical Port	25
4.4.2	Removing a GBIC Optical Port	26
5	Technical Specifications	29
5.1	Power Supply Specifications	29
5.2	Failsafe Relay Specifications	29
5.3	Supported Networking Standards	29
5.4	Copper Ethernet Port Specifications	30
5.5	Fiber Optic Ethernet Port Specifications	31
5.6	Operating Environment	32
5.7	Mechanical Specifications	33
5.8	Dimension Drawings	33
6	Certification	37
6.1	Approvals	37
6.1.1	UKCA	37
6.1.2	CSA	37
6.1.3	European Union (EU)	38
6.1.4	FCC	38
6.1.5	FDA/CDRH	39
6.1.6	ISED	39
6.1.7	ISO	39
6.1.8	ACMA	39
6.1.9	RoHS	40
6.1.10	Other Approvals	40
6.2	EMC and Environmental Type Tests	40

Preface

This guide describes the RUGGEDCOM RSG2300. It describes the major features of the device, installation, commissioning and important technical specifications.

It is intended for use by network technical support personnel who are responsible for the installation, commissioning and maintenance of the device. It is also recommended for use by network and system planners, system programmers, and line technicians.

Related Documents

Other documents that may be of interest include:

Document Title	Link
RUGGEDCOM ROS Configuration Manual	
RUGGEDCOM SFP Transceiver Catalog	https://support.industry.siemens.com/cs/ca/en/view/109482309

SIMATIC NET Glossary

The SIMATIC NET Glossary describes special terms that may be used in this document.

The glossary is available online via Siemens Industry Online Support (SIOS) at:

<https://support.industry.siemens.com/cs/ww/en/view/50305045>

Accessing documentation

The latest user documentation for RUGGEDCOM RSG2300 is available online at <https://support.industry.siemens.com>. To request or inquire about a user document, contact Siemens Customer Support.

Registered trademarks

The following and possibly other names not identified by the registered trademark sign ® are registered trademarks of Siemens Canada Ltd.:

- RUGGEDCOM
- ROS
- RCDP

- Discovery Protocol

Other designations in this manual might be trademarks whose use by third parties for their own purposes would infringe the rights of the owner.

Warranty

Siemens warrants this product for a period of five (5) years from the date of purchase, conditional upon the return to factory for maintenance during the warranty term. This product contains no user-serviceable parts. Attempted service by unauthorized personnel shall render all warranties null and void. The warranties set forth in this article are exclusive and are in lieu of all other warranties, performance guarantees and conditions whether written or oral, statutory, express or implied (including all warranties and conditions of merchantability and fitness for a particular purpose, and all warranties and conditions arising from course of dealing or usage or trade). Correction of nonconformities in the manner and for the period of time provided above shall constitute the Seller's sole liability and the Customer's exclusive remedy for defective or nonconforming goods or services whether claims of the Customer are based in contract (including fundamental breach), in tort (including negligence and strict liability) or otherwise.

For warranty details, visit <https://www.siemens.com> or contact a Siemens customer service representative.

Training

Siemens offers a wide range of educational services ranging from in-house training of standard courses on networking, Ethernet switches and routers, to on-site customized courses tailored to the customer's needs, experience and application.

Siemens' Educational Services team thrives on providing our customers with the essential practical skills to make sure users have the right knowledge and expertise to understand the various technologies associated with critical communications network infrastructure technologies.

Siemens' unique mix of IT/Telecommunications expertise combined with domain knowledge in the utility, transportation and industrial markets, allows Siemens to provide training specific to the customer's application.

For more information about training services and course availability, visit <https://www.siemens.com> or contact a Siemens Sales representative.

Customer support

Customer support is available 24 hours, 7 days a week for all Siemens customers. For technical support or general information, contact Siemens Customer Support through any of the following methods:



Online

Visit <http://www.siemens.com/automation/support-request> to submit a Support Request (SR) or check on the status of an existing SR.

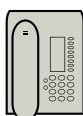

Telephone

Call a local hotline center to submit a Support Request (SR). To locate a local hotline center, visit https://w3.siemens.com/aspa_app/?lang=en.

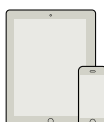

Mobile app

Install the Industry Online Support app by Siemens AG on any Android, Apple iOS or Windows mobile device and be able to:

- Access Siemens' extensive library of support documentation, including FAQs and manuals
- Submit SRs or check on the status of an existing SR
- Contact a local Siemens representative from Sales, Technical Support, Training, etc.
- Ask questions or share knowledge with fellow Siemens customers and the support community

Contacting Siemens

Address	Siemens Canada Ltd. Digital Industries Process Automation 300 Applewood Crescent Concord, Ontario Canada, L4K 5C7
Telephone	Toll-free: 1 888 264 0006 Tel: +1 905 856 5288 Fax: +1 905 856 1995
E-Mail	info.ruggedcom@siemens.com
Web	https://www.siemens.com

Introduction

The RUGGEDCOM RSG2300 is a rugged, fully managed, modular Ethernet switch specifically designed to operate reliably in electrically harsh and climatically demanding utility substation, railway and industrial environments. The RUGGEDCOM RSG2300's superior rugged hardware design coupled with the embedded Rugged Operating System (ROS) provides improved system reliability and advanced cyber security and networking features, making it ideally suited for creating Ethernet networks for mission-critical, real-time, control applications.

The RUGGEDCOM RSG2300's modular flexibility offers 1000BaseX fiber and 10/100/1000BaseTX copper port combinations. Optional front or rear mount connectors make the RUGGEDCOM RSG2300 highly versatile for any application and can support multiple fiber connectors (SFP, GBIC, LC, SC) without loss of port density. The RUGGEDCOM RSG2300 is packaged in a rugged galvanized steel enclosure with industrial grade DIN, panel, or 48 cm (19 in) rack-mount mounting options.

1.1 Feature Highlights

Ethernet Ports

- Up to x Gigabit Ethernet ports (copper and fiber)
- Up to x 100Base-FX Fiber Fast Ethernet ports
- 24 x 10/100TX Copper Ports
- {Optional} 4 x 1000Base-LX Gigabit Ethernet ports (copper and/or fiber)
- (Optional) 8 x 100Base-FX Fiber Fast Ethernet ports
- 2-port modules for tremendous flexibility
- Non-blocking, store and forward switching
- Supports many types of fiber (multimode, single mode, bidirectional single strand)
- Full compliance with IEEE: 802.3, 802.3u & 802.3z
- Full duplex operation and flow control (IEEE 802.3x)
- Long haul optics allow Gigabit at distances up to 90 km
- Pluggable Optic module support: SFP, GBIC
- Multiple connector types (ST, MTRJ, LC, SC)

Rated for Reliability in Harsh Environments

- Immunity to EMI and heavy electrical surges
- Zero-Packet-Loss™ technology
- -40 to 85 °C (-40 to 185 °F) operating temperature (no fans)
- Conformal coated printed circuit boards (optional)
- 18 AWG galvanized steel enclosure

Universal Power Supply Options

- Fully integrated, dual-redundant (optional) power supplies
- Universal high-voltage range: 88-300 VDC or 85-264 VAC
- Popular low voltage ranges: 24 VDC (12-36 VDC), 48 VDC (36-59 VDC)
- Screw or pluggable terminal blocks for reliable, maintenance-free connections
- CSA/UL 62368-1 safety approved to 85 °C (185 °F)

1.2 Description

The RUGGEDCOM RSG2300 features various ports, controls and indicator LEDs on the display panel for connecting, configuring and troubleshooting the device. The display panel can be located on the rear, front or top of the device, depending on the mounting configuration.

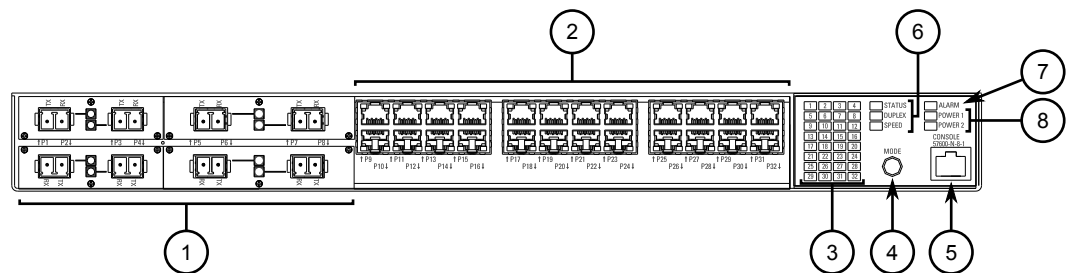

- ① Fiber or Copper Ethernet Ports
- ② Copper Ethernet Port
- ③ Port Status Indicator LEDs
- ④ Mode Button
- ⑤ RS-232 Serial Console Port (RJ45)
- ⑥ Display Mode Indicator LEDs
- ⑦ Alarm Indicator LED
- ⑧ Power Module Indicator LEDs

Figure 1.1 RUGGEDCOM RSG2300

Communication Ports

Ports for communicating with other devices or accessing the RUGGEDCOM RSG2300 operating system are described in "Communication Ports" (Page 21).

Port Status Indicator LEDs

Port status indicator LEDs indicate the operational status of each port, dependent on the currently selected mode.

Mode	Color/State	Description
Status	Green (Solid)	Link detected
	Green (Blinking)	Link activity
	Off	No link detected
Duplex	Green	Full duplex mode
	Orange	Half duplex mode
	Off	No link detected
Speed	Green (Solid)	100 Mbps
	Green (Blinking)	1000 Mbps
	Orange (Solid)	10 Mbps
	Off	No link detected

Display Mode Indicator LEDs

The display mode indicator LEDs indicate the current display mode for the port status indicator LEDs (i.e. Status, Duplex or Speed).

Mode Button

The **Mode** button sets the display mode for the port status indicator LEDs (i.e. Status, Duplex or Speed). It can also be used to reset the device if held for 5 seconds.

Alarm Indicator LED

The alarm indicator LED illuminates when an alarm condition exists.

Power Module Indicator LEDs

The power module indicator LEDs indicate the status of the power modules.

- **Green** – The power supply is supplying power
- **Red** – Power supply failure
- **Off** – No power supply is installed

RS-232 Console Port

The serial console port is for interfacing directly with the device and accessing initial management functions. For information about connecting to the device via the serial console port, refer to "Connecting to the Device" (Page 19).

1.3 Required Tools and Materials

The following tools and materials are required to install the RUGGEDCOM RSG2300:

Tools/Materials	Purpose
AC power cord (16 AWG)	For connecting power to the device.
CAT-5 Ethernet cables	For connecting the device to the network.
Flathead screwdriver	For mounting the device to a DIN rail.
Phillips screwdriver	For mounting the device to a panel.
4 x #8-32 screws	For mounting the device to a panel.

1.4 Decommissioning and disposal

Proper decommissioning and disposal of this device is important to prevent malicious users from obtaining proprietary information and to protect the environment.

Decommissioning

This device may include sensitive, proprietary data. Before taking the device out of service, either permanently or for maintenance by a third-party, make sure it has been fully decommissioned.

For more information, refer to the associated "RUGGEDCOM ROS Configuration Manual".

Recycling and disposal

This device is low in pollutants, can be recycled, and meets the requirements of the WEEE directive 2012/19/EU for the disposal of electrical and electronic equipment.

Do not dispose of devices at public disposal sites.

For environmentally friendly recycling and the disposal of devices, contact a certified disposal company for electronic scrap or your Siemens contact.

For more information, refer to <https://support.industry.siemens.com/cs/ww/en/view/109479891>.

Note the different national regulations.

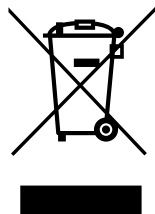

1.5 Cabling Recommendations

Before connecting the device, be aware of the recommendations and considerations outlined in this section.

1.5.1 Protection On Twisted-Pair Data Ports

All copper Ethernet ports on RUGGEDCOM products include transient suppression circuitry to protect against damage from electrical transients and conform with IEC 61850-3 and IEEE 1613 Class 1 standards. This means that during a transient electrical event, communications errors or interruptions may occur, but recovery is automatic.

Siemens also does not recommend using copper Ethernet ports to interface with devices in the field across distances that could produce high levels of ground potential rise (i.e. greater than 2500 V), during line-to-ground fault conditions.

1.5.2 Gigabit Ethernet 1000Base-TX Cabling Recommendations

The IEEE 802.3ab Gigabit Ethernet standard defines 1000 Mbit/s Ethernet communications over distances of up to 100 m (328 ft) using all 4 pairs in category 5 (or higher) balanced, unshielded twisted-pair cabling. For wiring guidelines, system designers and integrators should refer to the Telecommunications Industry Association (TIA) TIA/EIA-568-A wiring standard that characterizes minimum cabling performance specifications required for proper Gigabit Ethernet operation. For reliable, error-free data communication, new and pre-existing communication paths should be verified for TIA/EIA-568-A compliance.

The following table summarizes the relevant cabling standards:

Cabling Category	1000Base-TX Compliant	Required Action
< 5	No	New wiring infrastructure required.
5	Yes	Verify TIA/EIA-568-A compliance.
5e	Yes	No action required. New installations should be designed with Category 5e or higher.
6	Yes	No action required.
> 6	Yes	Connector and wiring standards to be determined.

Follow these recommendations for copper data cabling in high electrical noise environments:

- Data cable lengths should be as short as possible, preferably 3 m (10 ft) in length. Copper data cables should not be used for inter-building communications.
- Power and data cables should not be run in parallel for long distances, and should be installed in separate conduits. Power and data cables should intersect at 90° angles when necessary to reduce inductive coupling.
- Shielded/screened cabling can be used when required. Care should be taken to avoid the creation of ground loops with shielded cabling.

1.5.3 Supported fiber optic cables

The following fiber optic cable types are supported under the stated conditions.

Cable Type	Wavelength (nm)	Modal Bandwidth (MHz·km)	Distance (m)		
			100Base-FX	1000Base-SX	10GBase-SR
OM1 (62.5/125)	850	200	—	275	33
	1300	500	2000	—	—
OM2 (50/125)	850	500	—	550	82
	1300	500	2000	—	—
OM3 (50/125) ^a	850	1500	—	550	300
	1300	500	2000	—	—
OM4 (50/125) ^a	850	3500	—	550	400

Introduction

1.5.3 Supported fiber optic cables

Cable Type	Wavelength (nm)	Modal Bandwidth (MHz·km)	Distance (m)		
			100Base-FX	1000Base-SX	10GBase-SR
	1300	500	2000	—	—

^a Laser optimized.

Installing the Device

This chapter describes how to install the device, including mounting the device, connecting power, and connecting the device to the network.



⚠ DANGER

Electrocution hazard – risk of serious personal injury and/or damage to equipment.

Before performing any maintenance tasks, make sure all power to the device has been disconnected and wait approximately two minutes for any remaining energy to dissipate.



⚠ WARNING

Radiation hazard – risk of serious personal injury

This product contains a laser system and is classified as a *CLASS 1 LASER PRODUCT*. Use of controls or adjustments or performance of procedures other than those specified herein may result in hazardous radiation exposure.

⚠ WARNING

Fire/electrical/burn hazard – risk of serious personal injury and/or damage to the device

Do not use any parts that show evidence of damage. If damaged parts are used, the device may not function according to the specification. Damaged parts can lead to:

- Injury to personnel
- Loss of certification/approvals
- Violation of EMC regulations
- Damage to the device or other components

⚠ NOTICE

This product contains no user-serviceable parts. Attempted service by unauthorized personnel shall render all warranties null and void.

Changes or modifications not expressly approved by Siemens Canada Ltd. could invalidate specifications, test results, and agency approvals, and void the user's authority to operate the equipment.

⚠ NOTICE

This product should be installed in a *restricted access location* where access can only be gained by authorized personnel who have been informed of the restrictions and

any precautions that must be taken. Access must only be possible through the use of a tool, lock and key, or other means of security, and controlled by the authority responsible for the location.

2.1 General Procedure

The general for installing the device is as follows:

 NOTICE
The user is responsible for the operating environment of the device, including maintaining the integrity of all protective conductor connections and checking equipment ratings. Make sure to review all operating and installation instructions before commissioning or performing maintenance on the device.

1. Review the relevant certification information for any regulatory requirements. For more information, refer to "Approvals" (Page 37).
2. Mount the device.
3. Connect the failsafe alarm relay.
4. Connect power to the device and ground the device to safety Earth.
5. Connect the device to the network.
6. Configure the device.

2.2 Unpacking the device

When unpacking the device, do the following:

1. Inspect the package for damage before opening it.
2. Visually inspect each item in the package for any physical damage.
3. Verify all items are included.

Note

If any item is missing or damaged, contact Siemens for assistance.

2.3 Mounting the Device

The RUGGEDCOM RSG2300 is designed for maximum mounting and display flexibility. It can be equipped with connectors that allow it to be installed in a 48 cm (19 in) rack, 35 mm (1.4 in) DIN rail, or directly on a panel.

⚠ NOTICE

Heat generated by the device is channeled outwards from the enclosure. As such, it is recommended that 2.5 cm (1 in) of space be maintained on all open sides of the device to allow for some convectational airflow.

Forced airflow is not required. However, any increase in airflow will result in a reduction of ambient temperature and improve the long-term reliability of all equipment mounted in the rack space.

Note

For detailed dimensions of the device with either rack, DIN rail or panel hardware installed, refer to "Dimension Drawings" (Page 33).

2.3.1 Mounting the Device to a Rack

The RUGGEDCOM RSG2300 can be secured to a standard 48 cm (19 in) rack using separately purchased rack mount adapters. The adapters can be installed at the front or rear of the chassis.

Each adapter kit includes four adapters.

⚠ NOTICE**Vibration hazard – risk of damage to the device**

In high-vibration or seismically active locations, always install four rack mount adapters (two at the front of the chassis and two at the rear).

⚠ NOTICE**Electrical/mechanical hazard – risk of damage to the device**

Before installing the device in a rack, make sure of the following:

- When installing the device in a closed or multi-device rack, be aware the operating ambient temperature of the rack may be higher than the ambient temperature of the room. Make sure the rack is installed in a suitable environment that can withstand the maximum ambient temperature generated by the rack.
- Make sure each device in the rack is separated by at least one rack-unit of space, or 44 mm (1.75 in), to promote convectational airflow. Forced airflow is not required. However, any increase in airflow will result in a reduction of ambient temperature and improve the long-term reliability of all equipment mounted in the rack space.
- Do not exceed the maximum number of devices or weight restrictions specified by the rack manufacturer.
- Do not overload the supply circuit. Refer to the over-current protection and power supply ratings specified by the rack manufacturer.

2.3.2 Mounting the Device on a DIN Rail

- Make sure the rack and all devices have a proper ground-to-Earth connection. Pay particular attention to power supply connections other than direct connections to the branch circuit (e.g. power strips).

To secure the device to a standard 48 cm (19 in) rack, do the following:

Note

The device can be ordered with the communication ports located at the front or rear of the device. Placing the ports at the rear allows all data and power cabling to be installed and connected at the rear of the rack.

1. Make sure the rack mount adapters are installed on the correct side of the chassis.
 - To make the modules and ports accessible, install the rack mount adapters at the rear of the chassis
 - To make the management ports and LEDs accessible, install the rack mount adapters at the front of the chassis

Note

The chassis features multiple mounting holes, allowing the rack mount adapters to be installed up to 25 mm (1 in) from the face of the device.

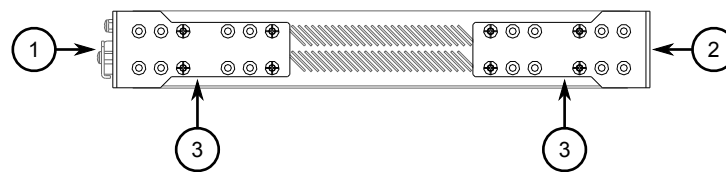

- ① Rear
- ② Front
- ③ Rack Mount Adapter

Figure 2.1 Rack Mount Adapters

2. If required, install adapters on the opposite side of the device to protect from vibrations.
3. Insert the device into the rack.
4. Secure the adapters to the rack using the supplied hardware.

2.3.2 Mounting the Device on a DIN Rail

For DIN rail installations, the RUGGEDCOM RSG2300 can be equipped with panel/DIN rail adapters pre-installed on each side of the chassis. The adapters allow the device to be slid onto a standard 35 mm (1.4 in) DIN rail.

⚠ NOTICE

DIN rail mounting is not recommended for constant vibration environments.

To mount the device to a DIN rail, do the following:

1. Align the adapters with the DIN rails and slide the device into place.

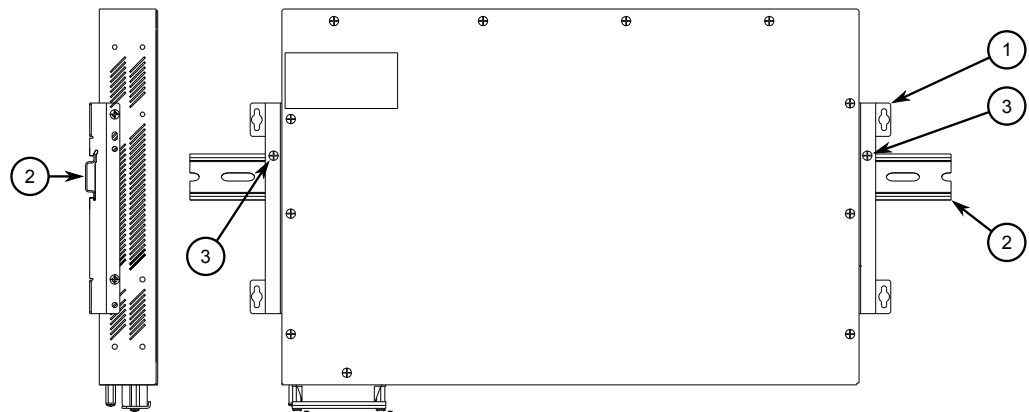

- ① Panel/DIN Rail Adapter
- ② DIN Rail
- ③ Screw

Figure 2.2 DIN Rail Mounting

2. Install one of the supplied screws on either side of the device to secure the adapters to the DIN rails.

2.3.3 Mounting the Device to a Panel

For panel installations, the RUGGEDCOM RSG2300 can be equipped with panel/DIN rail adapters pre-installed on each side of the chassis. The adapters allow the device to be attached to a panel using screws.

To mount the device to a panel, do the following:

1. Place the device against the panel and align the adapters with the mounting holes.

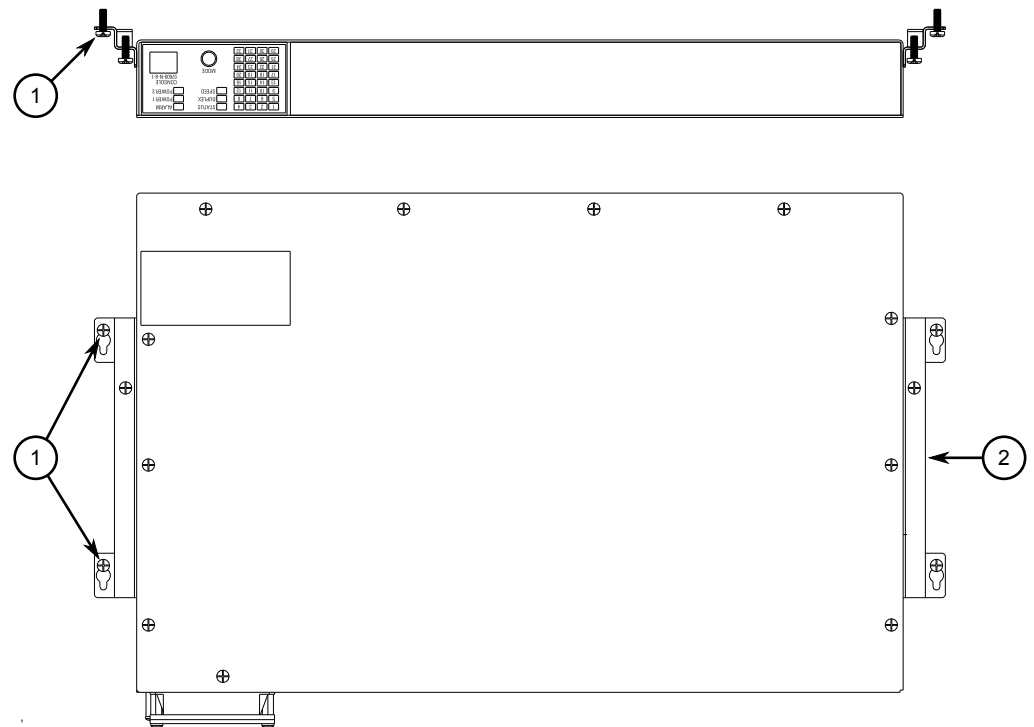

- ① Screw
- ② Panel/DIN Rail Adapter

Figure 2.3 Panel Mounting

2. Install the supplied screws to secure the adapters to the panel.

2.4 Connecting the Failsafe Alarm Relay

The failsafe relay can be configured to latch based on alarm conditions. The NO (Normally Open) contact is closed when the unit is powered and there are no active alarms. If the device is not powered or if an active alarm is configured, the relay opens the NO contact and closes the NC (Normally Closed) contact.

Note

Control of the failsafe relay output is configurable through RUGGEDCOM RSG2300. One common application for this relay is to signal an alarm if a power failure occurs. For more information, refer to the "RUGGEDCOM ROS Configuration Manual" for the RUGGEDCOM RSG2300.

The following shows the proper relay connections.

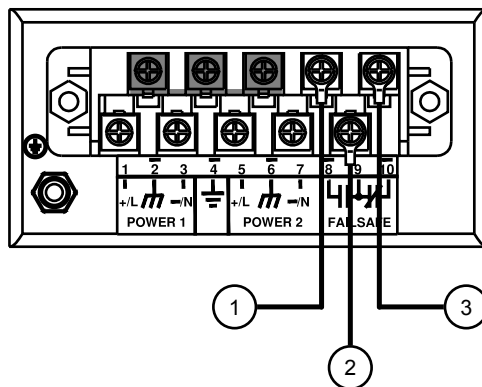

- ① Normally Open
- ② Common
- ③ Normally Closed

Figure 2.4 Failsafe Alarm Relay Wiring

2.5 Connecting Power

The RUGGEDCOM RSG2300 supports a single or dual redundant AC and/or DC power supplies.

The RUGGEDCOM RSG2300 can be equipped with either a screw-type or pluggable terminal block, which provides power to both power supplies. The screw-type terminal block is installed using Phillips screws and compression plates, allowing either bare wire connections or crimped terminal lugs. Use #6 size ring lugs for secure, reliable connections under severe shock or vibration.

NOTICE

Electrical hazard – risk of damage to the device

Make sure power input to the device is within the specified input range. For information about the nominal input range for the device, refer to "Power Supply Specifications" (Page 29).

Note

- For maximum redundancy in a dual power supply configuration, use two independent power sources.
- Use minimum #16 gage copper wiring when connecting terminal blocks.
- For 110/230 VAC rated equipment, an appropriately rated AC circuit breaker must be installed.
- For 125/250 VDC rated equipment, an appropriately rated DC circuit breaker must be installed.
- A circuit breaker is not required for 12, 24 or 48 VDC rated power supplies.

- It is recommended to provide a separate circuit breaker for each power supply module.
- Equipment must be installed according to applicable local wiring codes and standards.

2.5.1 Connecting AC or DC Power

To connect a single high AC, high DC or low DC power supply to the device, do the following:

 **NOTICE**

Electrical hazard – risk of damage to equipment

Before testing the dielectric strength (HIPOT) in the field, remove the metal jumper. This metal jumper connects transient suppression circuitry to chassis ground and must be removed in order to avoid damage to transient suppression circuitry during testing.

 **NOTICE**

Electrical hazard – risk of damage to equipment

Do not connect AC power cables to a 24 or 48 VDC power supply. Damage to the power supply may occur.

 **NOTICE**

Each internal power module is labeled POWER 1 or POWER 2. Make sure to connect the power supply to the corresponding internal power module.

1. Remove the terminal block cover.
2. Identify the internal power module (POWER 1 or POWER 2) appropriate for the power supply (AC or DC).
3. Use these screws along with #6 ring lugs to secure the wires to the terminal block.

Note

For wiring options, refer to "Wiring Examples" (Page 16).

4. Connect the positive wire from the power source to the positive/live (+/L) terminal on the terminal block.

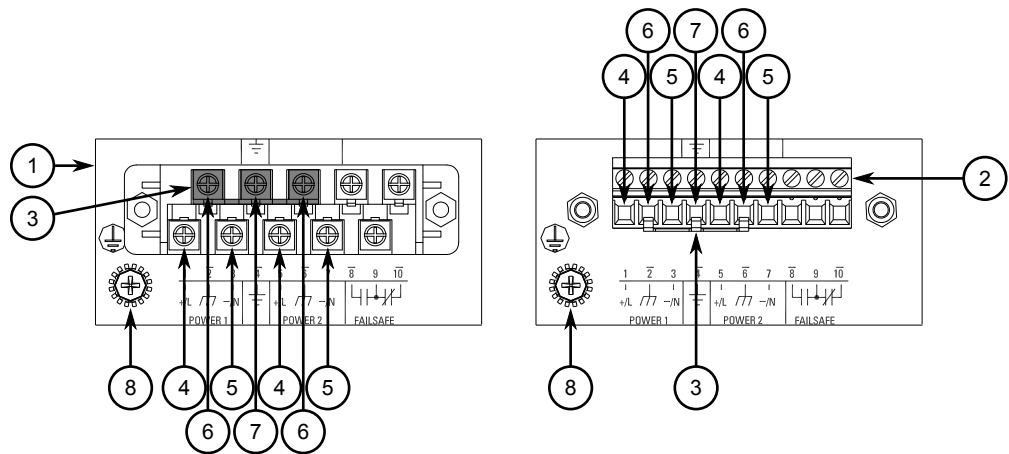

- ① Screw-Type Terminal Block
- ② Pluggable Terminal Block
- ③ Jumper
- ④ Positive/Live (+/L) Terminal
- ⑤ Negative/Neutral (-/N) Terminal (-/N)
- ⑥ Surge Ground Terminal
- ⑦ Chassis Ground Terminal
- ⑧ Chassis Ground Connection

Figure 2.5 Terminal Block Wiring

5. Connect the negative wire from the power source to the negative/neutral (-/N) terminal on the terminal block.
6. Install the supplied metal jumper between terminals 2, 4 and 6 to connect the surge ground terminals to the chassis ground terminal. The surge ground terminals are used as the ground conductor for all surge and transient suppression circuitry internal to the unit.
7. Using a #6 ring lug and #6-32 screw, secure the ground terminal on the power source to the chassis ground connection on the device. Make sure the lug is tightened to 1.7 N·m (15 lbf·in).

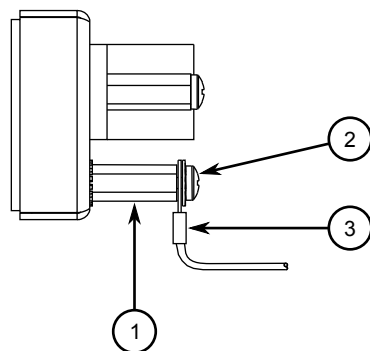

- ① Stainless Steel Stud
- ② #6-32 Screw

③ #6 Ring Lug

Figure 2.6 Chassis Ground Connection

⚠ DANGER
Electrocution hazard – risk of death, serious personal injury and/or damage to the device
Make sure the supplied terminal block cover is always installed before the device is powered.

8. Install the terminal block cover.

2.5.2 Wiring Examples

The following illustrate how to connect power to single and dual power supplies.

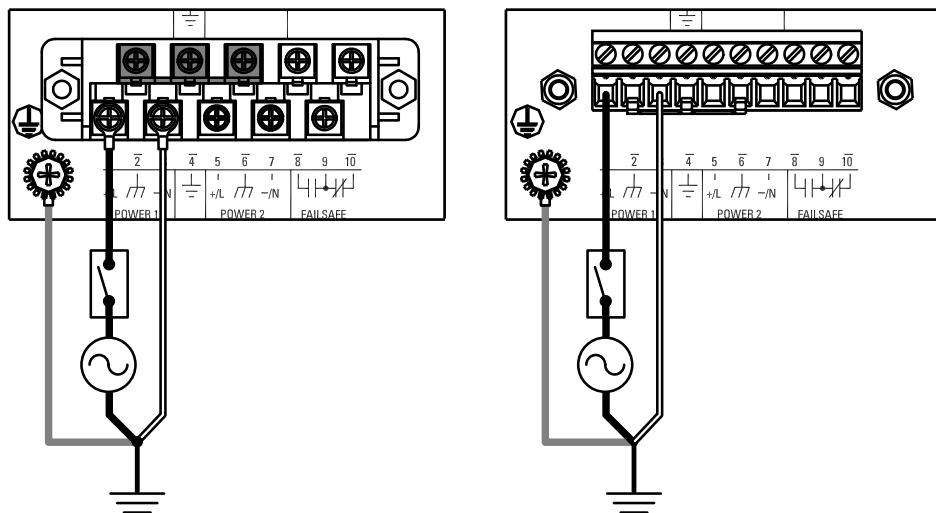

Figure 2.7 Single AC Power Supply

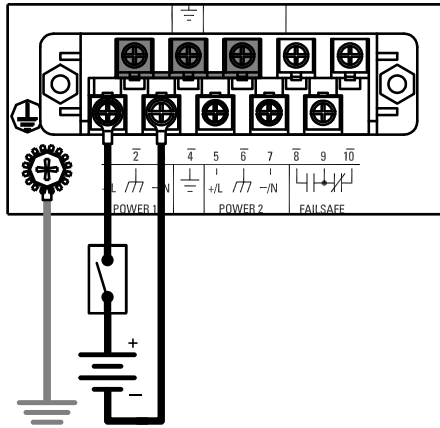

Figure 2.8 Single DC Power Supply

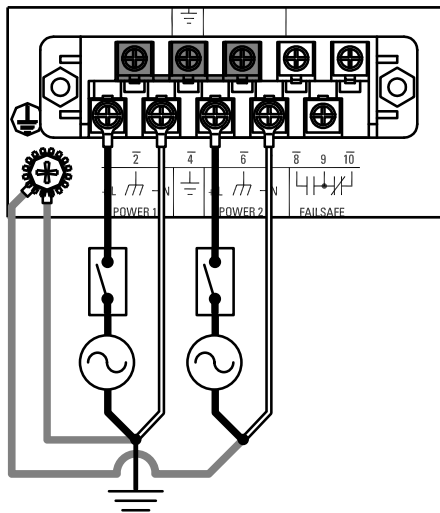
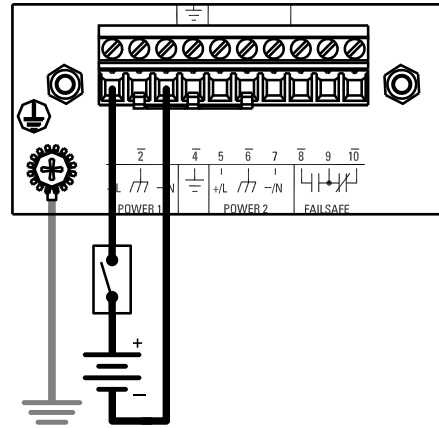
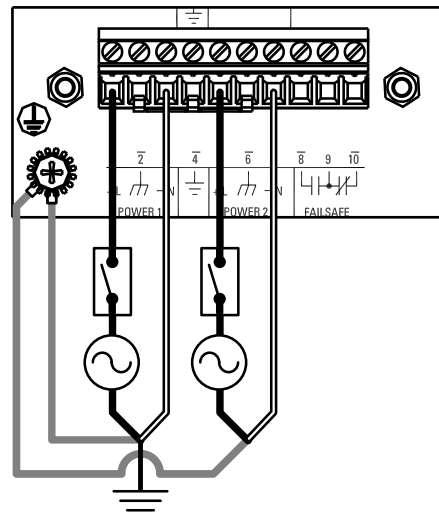

Figure 2.9 Dual AC Power Supply



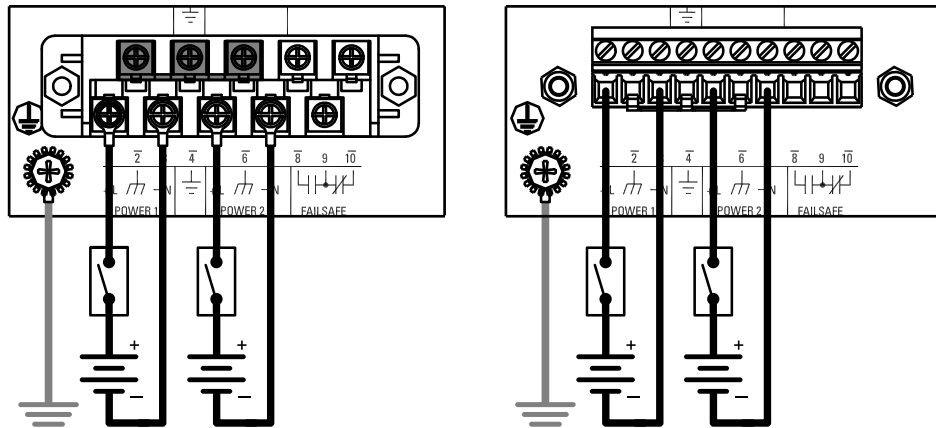

Figure 2.10 Dual DC Power Supply

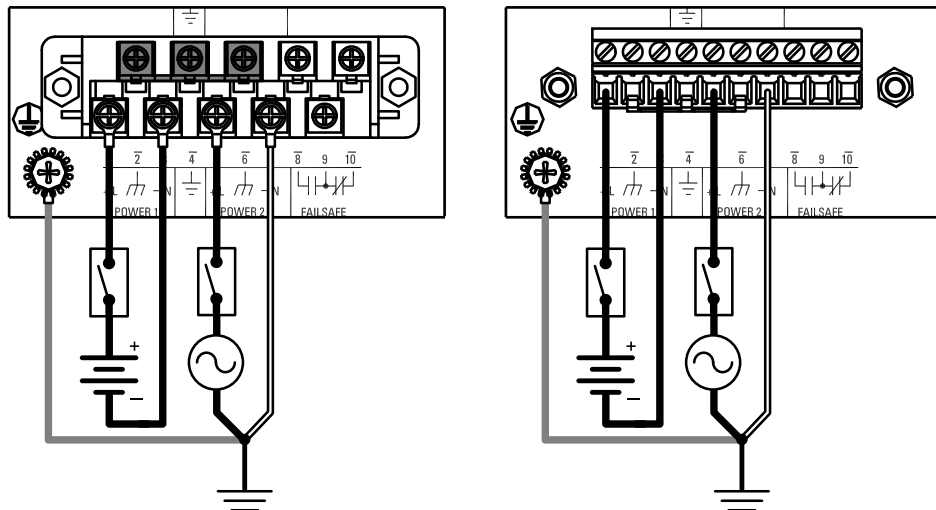

Figure 2.11 Dual AC/DC Power Supply

Device Management

This section describes how to connect to and manage the device.

3.1 Connecting to the Device

The following describes the various methods for accessing the RUGGEDCOM RSG2300 console and Web interfaces on the device. For more detailed instructions, refer to the "RUGGEDCOM ROS Configuration Manual" for the RUGGEDCOM RSG2300.

RS232 Console Port

Connect a workstation directly to the RS232 console port to access the boot-time control and RUGGEDCOM RSG2300 interfaces. The console port provides access to RUGGEDCOM RSG2300's console and Web interfaces.

NOTICE

The serial console port is intended to be used only as a temporary connection during initial configuration or troubleshooting.

Connection to the console port is made using an RJ45-to-DB9 console cable. The following is the pin-out for the console port:

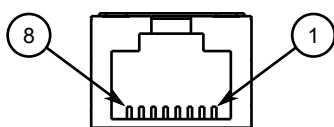

Figure 3.1 RJ45 Console Port Pin Configuration

Pin		Name	Description	Comment
RJ45 Male	DB9 Female			
1	6	DSR ^a	Data Set Ready	
2	1	DCD ^a	Carrier Detect	Reserved (Do Not Connect)
3	4	DTR ^a	Data Terminal Ready	
4	5	GND	Signal Ground	
5	2	RxD	Receive Data (to DTE)	
6	3	TxD	Transmit Data (from DTE)	
7	8	CTS ^b	Clear to Send	
8	7	RTS ^b	Read to Send	

3.2 Configuring the Device

Pin		Name	Description	Comment
RJ45 Male	DB9 Female			
1	9	RI ^c	Ring Indicator	

^a The DSR, DCD and DTR pins are connected together internally.

^b The CTS and RTS pins are connected together internally.

^c RI is not connected.

Communication Ports

Connect any of the available Ethernet ports on the device to a management switch and access the RUGGEDCOM RSG2300 console and Web interfaces via the device's IP address. For more information about available ports, refer to "Communication Ports" (Page 21).

3.2 Configuring the Device

Once the device is installed and connected to the network, it must be configured. All configuration management is done via the RUGGEDCOM RSG2300 interface. For more information about configuring the device, refer to the "RUGGEDCOM ROS Configuration Manual" associated with the installed software release.

Communication Ports

The RUGGEDCOM RSG2300 can be equipped with various types of communication ports to enhance its abilities and performance.

Module Assignment

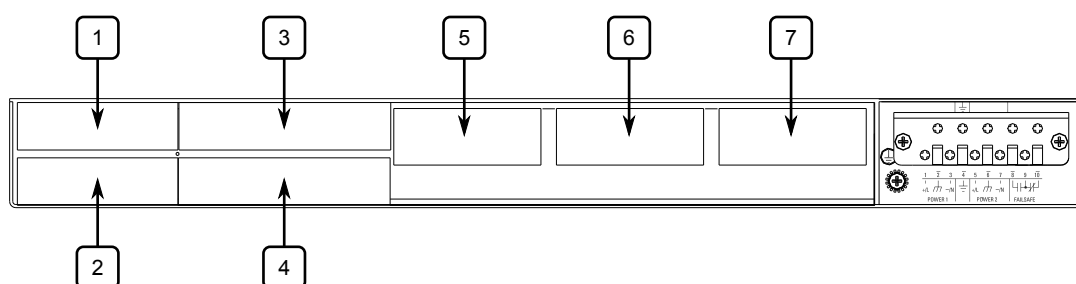

Figure 4.1 Module Assignment

Each type of module has a specific location in the RUGGEDCOM RSG2300 chassis:

- Slots 1 and 2 support any combination of two-port fiber or copper Ethernet modules up to 100 Mbps
- Slots 3 and 4 support any combination of two-port Gigabit Ethernet (1 Gbps) ports
- Slots 5, 6 and 7 house 8-port 10/100TX copper RJ45 Ethernet ports, totaling 24 ports

The exact configuration of the device can be determined by reading the factory data file through the RUGGEDCOM RSG2300 user interface. For more information about how to read the factory data file, refer to the "RUGGEDCOM ROS Configuration Manual" for the RUGGEDCOM RSG2300.

Port LEDs

Each communication port is equipped with an LED that indicates the link/activity state of the port.

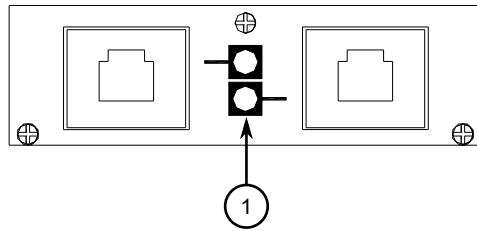

① Port LED

Figure 4.2 Port LEDs

LED State	Description
Yellow (Solid)	Link established
Yellow (Blinking)	Link activity
Off	No link detected

4.1 Copper Ethernet Ports

The RUGGEDCOM RSG2300 supports several 10/100/1000Base-TX Ethernet ports that allow connection to standard Category 5 (CAT-5) unshielded twisted-pair (UTP) cables with either RJ45 male connectors. The RJ45 connectors are directly connected to the chassis ground on the device and can accept CAT-5 shielded twisted-pair (STP) cables.

<p>⚠ WARNING</p> <p>Electric shock hazard – risk of serious personal injury and/or equipment interference</p> <p>If shielded cables are used, make sure the shielded cables do not form a ground loop via the shield wire and the RJ45 receptacles at either end. Ground loops can cause excessive noise and interference, but more importantly, create a potential shock hazard that can result in serious injury.</p>

Pin-Out

The following is the pin-out description for the RJ45 connectors:

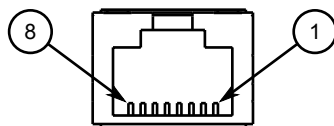

Figure 4.3 RJ45 Ethernet Port Pin Configuration

Pin	Name		Description
	10/100Base-TX	1000Base-TX	
1	RX+	BI_DA+	Receive Data+ or Bi-Directional Pair A+
2	RX-	BI_DA-	Receive Data- or Bi-Directional Pair A-
3	TX+	BI_DB+	Transmit Data+ or Bi-Directional Pair B+
4	Reserved (Do Not Connect)	BI_DC+	Transmit Data+ or Bi-Directional Pair C+
5	Reserved (Do Not Connect)	BI_DC-	Receive Data- or Bi-Directional Pair C-
6	TX-	BI_DB-	Transmit Data- or Bi-Directional Pair B-
7	Reserved (Do Not Connect)	BI_DD+	Receive Data- or Bi-Directional Pair D+
8	Reserved (Do Not Connect)	BI_DD-	Receive Data- or Bi-Directional Pair D-

Specifications

For specifications on the available copper Ethernet ports, refer to "Copper Ethernet Port Specifications" (Page 30).

4.2 Fiber Optic Ethernet Ports

Fiber optic Ethernet ports are available with either MTRJ (Mechanical Transfer Registered Jack), LC (Lucent Connector), SC (Standard or Subscriber Connector) or ST (Straight Tip) connectors. Make sure the Transmit (Tx) and Receive (Rx) connections of each port are properly connected and matched to establish a proper link.

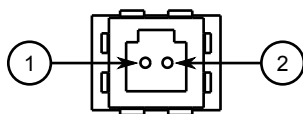

- ① Tx Connector
- ② Rx Connector

Figure 4.4 MTRJ Port

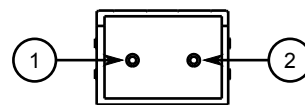

- ① Tx Connector
- ② Rx Connector

Figure 4.5 LC Port

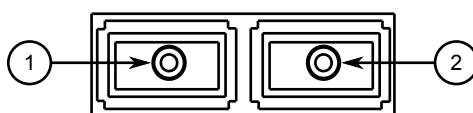

- ① Tx Connector

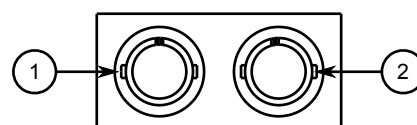

- ① Tx Connector

4.3 SFP Transceivers

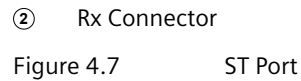
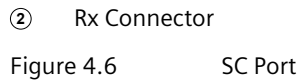

For specifications on the available fiber optic Ethernet ports, refer to "Fiber Optic Ethernet Port Specifications" (Page 31).

4.3 SFP Transceivers

The RUGGEDCOM RSG2300 supports up to two Small Form-Factor Pluggable (SFP) transceiver sockets, which are compatible with a wide array of SFP transceivers available from Siemens.

LEDs

Each socket features an LED that indicates its link state.

State	Description
Yellow (Solid)	Link established
Yellow (Blinking)	Activity
Off	No link detected

Compatible SFP Transceivers

For more information about which SFP transceivers are compatible with the RUGGEDCOM RSG2300, as well as instructions for ordering and installation/removal, refer to the "RUGGEDCOM SFP Transceiver Catalog [<https://support.industry.siemens.com/cs/ca/en/view/109482309>]".

<p>⚠ NOTICE</p> <p>Only use SFP transceivers approved by Siemens for RUGGEDCOM products. Siemens accepts no liability as a result of performance issues related in whole or in part to third-party components.</p>

4.4 GBIC Optic Ethernet Ports

GBIC (Gigabit Interface Converter) optic Ethernet ports are available with SC (Standard or Subscriber Connector) connectors.

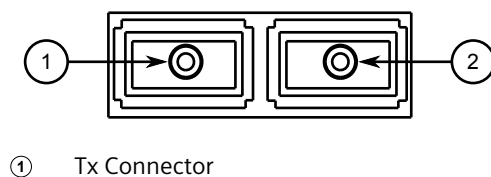

② Rx Connector

Figure 4.8 SC Port

4.4.1 Installing a GBIC Optical Port

To install a GBIC optical port, do the following:

⚠ NOTICE

Electrical hazard – risk of damage to equipment

Use only components certified by Siemens with RUGGEDCOM products. Damage to the module and device may occur if compatibility and reliability have not been properly assessed.

⚠ NOTICE

Electrical hazard – risk of damage to equipment

Make sure all electrostatic energy is dissipated before installing or removing components from the device. An electrostatic discharge (ESD) can cause serious damage to the component once it is outside the chassis.

⚠ NOTICE

Only install GBIC optical ports that are compatible with the RUGGEDCOM RSG2300.

1. Make sure all potential electrostatic build-up has been properly discharged to prevent electrostatic discharges (ESD). This can be accomplished by wearing an ESD-preventive wrist strap connected to either the chassis ground connector or a bare metal surface on the router/switch.
2. Remove the dust cover from the port opening in the module.
3. Remove the port from its packaging.

⚠ NOTICE

Mechanical hazard – risk of component damage

GBIC optical ports are designed to insert in only one orientation. Do not force the port into the module.

4. Remove the dust plug from the socket and store for future use.
5. Squeeze the latches on either side of the port and insert the port into the socket.

4.4.2 Removing a GBIC Optical Port

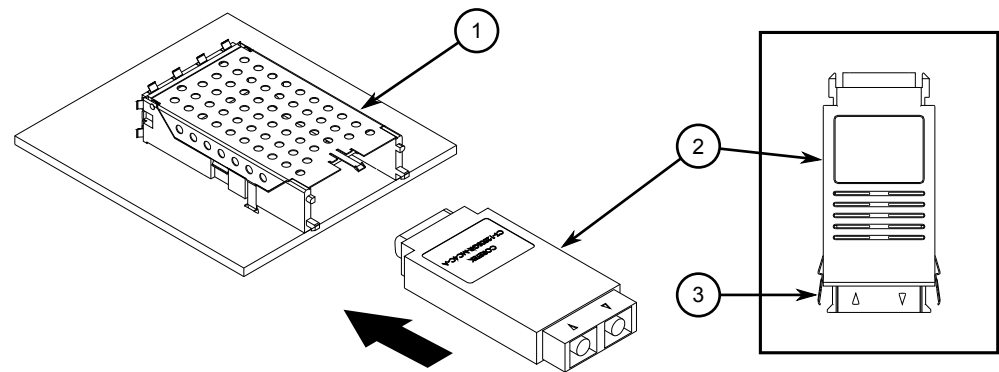

- ① GBIC Optical Port Module
- ② Socket
- ③ Locking Latch

Figure 4.9 Installing a GBIC Optical Port

6. Release the latches and make sure the port is locked in place.

⚠ NOTICE
 Only remove the dust plug when ready to connect a cable to the GBIC optical port.

7. Remove the dust cover from the port and store for future use.
8. Remove the dust cap from the cable and immediately connect it to the port.
9. Connect the cable to a network and observe the LED associated with the port. For more information about the LED, refer to "Communication Ports" (Page 21).

4.4.2 Removing a GBIC Optical Port

To remove an GBIC optical port, do the following:

⚠ NOTICE
Electrical hazard – risk of damage to equipment
 Make sure all electrostatic energy is dissipated before performing installing or removing components from the device. An electrostatic discharge (ESD) can cause serious damage to the component once it is outside the chassis.

1. Make sure all potential electrostatic build-up has been properly discharged to prevent an electrostatic discharge (ESD). This can be accomplished by wearing an ESD-preventive wrist trap connected to either the chassis ground connector or a bare metal surface on the router/switch.
2. Disconnect the cable from the port and install the dust cap to the cable end.

3. Squeeze the latches on either side of the port and pull it from the socket.

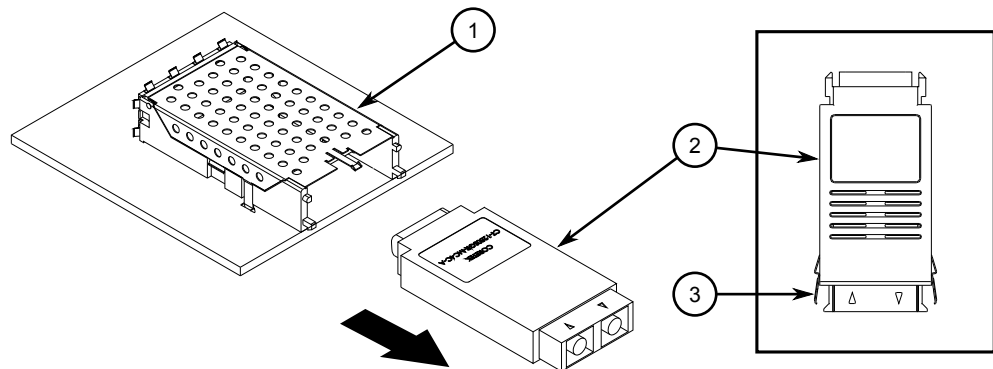

- ① Socket
- ② GBIC Optical Port
- ③ Locking Latch

Figure 4.10 Removing a GBIC Optical Port

4. Store the port in an ESD-safe bag or other suitable ESD-safe environment, free from moisture and stored at the proper temperature (-40 to 85 °C or -40 to 185 °F).
5. Insert a dust plug into the socket opening to prevent the ingress of dust and dirt.

Technical Specifications

This section details the specifications and operating conditions of the device.

5.1 Power Supply Specifications

The RUGGEDCOM RSG2300 can be equipped with the following power supplies:

 NOTICE
Electrical hazard – risk of damage to the device
Make sure power input to the device is within the specified input range.

Power Supply Type	Input Range		Internal Fuse Rating ^{ab}	Maximum Power Consumption ^c
	Minimum	Maximum		
24 VDC	10 VDC	36 VDC	6.3 A(F)	25 W
48 VDC	36 VDC	59 VDC	3.15 A(T)	
HI (125/250 VDC) ^d	88 VDC	300 VDC	2 A(T)	
HI (110/230 VAC) ^d	85 VAC	264 VAC	2 A(T)	

^a (F) denotes fast-acting fuse

^b (T) denotes time-delay fuse.

^c Power consumption varies based on configuration. 10/100Base-TX ports consume roughly 1 W less than fiber optic ports.

^d The HI power supply is the same power supply for both AC and DC.

5.2 Failsafe Relay Specifications

Maximum Switching Voltage	250 VAC, 125 VDC
Rated Switching Current	2 A @ 250 VAC, 0.15 A @ 125 VDC, 2 A @ 30 VDC
Maximum Switching Capacity	150 W, 500 VA

5.3 Supported Networking Standards

Standard	10 Mbps Ports	100 Mbps Ports	1000 Mbps Ports	Description
IEEE 802.3	✓			10BaseT/10BaseFL

Standard	10 Mbps Ports	100 Mbps Ports	1000 Mbps Ports	Description
IEEE 802.3u		✓		100BaseTX/100BaseFX
IEEE 802.3x	✓	✓	✓	Flow Control
IEEE 802.3z			✓	1000BaseLX
IEEE 802.3ab			✓	1000BaseTx
IEEE 802.3ad			✓	Link Aggregation
IEEE 802.1D	✓	✓	✓	MAC Bridges
IEEE 802.1D	✓	✓	✓	Spanning Tree Protocol (STP)
IEEE 802.1p	✓	✓	✓	Class of Service (CoS)
IEEE 802.1Q	✓	✓	✓	VLAN (Virtual LAN) Tagging
IEEE 802.1w	✓	✓	✓	Rapid Spanning Tree Protocol (RSTP)
IEEE 802.1x	✓	✓	✓	Port-Based Network Access Control
IEEE 802.1Q-2005 (formerly 802.1s)	✓	✓	✓	Multiple Spanning Tree Protocol (MSTP)

5.4 Copper Ethernet Port Specifications

The following details the specifications for copper Ethernet ports that can be ordered with the RUGGEDCOM RSG2300.

Note

- Maximum segment length is greatly dependent on factors such as fiber quality, and the number of patches and splices. Consult a Siemens sales associate when determining maximum segment distances.
- All optical power numbers are listed as dBm averages.
- F51 transceivers are rated for -40 to 85 °C (-40 to 185 °F).

Connector	Speed	Duplex ^a	Cable Type ^b	Wiring Standard ^c	Maximum Distance ^d	Isolation ^e
RJ45	10/100 Mbps	FDX/HDX	> CAT-5	TIA/EIA T568A/B	100 m (328 ft)	1.5 kV
RJ45	1000 Mbps	FDX/HDX	> CAT-5	TIA/EIA T568A/B	100 m (328 ft)	1.5 kV

^a Auto-Negotiating

^b Shielded or unshielded.

^c Auto-crossover and auto-polarity.

^d Typical distance. Dependent on the number of connectors and splices.

^e RMS 1 minute.

5.5 Fiber Optic Ethernet Port Specifications

The following details the specifications for fiber Ethernet ports that can be ordered with the RUGGEDCOM RSG2300.

10FL Ethernet Optical Specifications

Mode	Connector Type	Cable Type (µm)	Tx λ (nm) ^a	Tx (dBm)		Rx Sensitivity (dBm)	Rx Saturation (dBm)	Distance (km) ^b	Power Budget (dB)
				Minimum	Maximum				
MM	ST	62.5/125	850	-16	-9	-34	-11.2	2	18
MM	ST	50/125	850	-19.8	-12.8	-34	-11.2	2	14.2

^a Typical.

^b Typical distance. The maximum distance is greatly dependent on factors such as cable type, the number of connectors and number of splices. Consult a Siemens sales associates when determining maximum distances.

Fast Ethernet (10/100 Mbps) Optical Specifications

Mode	Connector Type	Cable Type (µm)	Tx λ (nm) ^a	Tx (dBm)		Rx Sensitivity (dBm)	Rx Saturation (dBm)	Distance (km) ^b	Power Budget (dB)
				Minimum	Maximum				
MM	ST	62.5/125	1300	-19	-14	-31	-14	2	12
MM	ST	50/125	1300	-22.5	-14	-31	-14	2	8.5
MM	SC	62.5/125	1300	-19	-14	-31	-14	2	12
MM	SC	50/125	1300	-22.5	-14	-31	-14	2	8.5
MM	MTRJ	62.5/125	1300	-19	-14	-31	-14	2	12
MM	MTRJ	50/125	1300	-22.5	-14	-31	-14	2	8.5
MM	LC	62.5/125	1310	-19	-14	-32	-14	2	13
SM	ST	9/125	1310	-15	-8	-32	-3	20	17
SM	SC	9/125	1310	-15	-8	-31	-7	20	16
SM	LC	9/125	1310	-15	-8	-34	-7	20	19
SM	SC	9/125	1310	-5	0	-34	-3	50	29
SM	LC	9/125	1310	-5	0	-35	3	50	30
SM	SC	9/125	1310	0	5	-37	0	90	37
SM	LC	9/125	1310	0	5	-37	0	90	37

^a Typical.

^b Typical distance. The maximum distance is greatly dependent on factors such as cable type, the number of connectors and number of splices. Consult a Siemens sales associates when determining maximum distances.

Gigabit Ethernet (1 Gbps) Optical Specifications

Note

These transceivers utilize a distributed feedback (DFB) type laser and are rated for -20 to 85 °C (-4 to 185 °F) operation only.

5.6 Operating Environment

Mode	Connector Type	Cable Type (μm) ^a	Tx λ (nm) ^b	Tx (dBm) ^c		Rx Sensitivity (dBm) ^c	Rx Saturation (dBm) ^c	Distance (km) ^d	Power Budget (dB)
				Minimum	Maximum				
MM	LC	50/125	850	-9	-2.5	-20	0	0.5	11
MM	LC	62.5/125	850	-9	-2.5	-20	0	0.5	11
SM	SC	9/125	1310	-10	-3	-20	-3	10	10
SM	LC	9/125	1310	-9.5	-3	-21	-3	10	11.5
SM	SC	9/125	1310	-5	0	-20	-3	25	15
SM	LC	9/125	1310	-7	-3	-24	-3	25	17

^a All cabling is duplex type unless specified otherwise.

^b Typical.

^c All optical power numbers are listed as dBm averages.

^d Typical distance. The maximum segment length is greatly dependent on factors such as fiber quality, and the number of patches and splices. Consult a Siemens sales associates when determining maximum segment distances.

GBIC Gigabit (1 Gbps) Transceiver Specifications

Note

GBIC transceivers have a temperature range of -40 to 85 °C (-40 to 185 °F), unless specified otherwise.

Mode	Connector Type	Cable Type (μm) ^a	Tx λ (nm) ^b	Tx (dBm) ^c		Rx Sensitivity (dBm) ^c	Rx Saturation (dBm) ^c	Distance (km) ^d	Power Budget (dB)
				Minimum	Maximum				
SM	SC	9/125	1310	-9.5	-3	-21	-3	10	11.5
SM	SC	9/125	1310	-7	-3	-24	-3	25	17
SM ^e	SC	9/125	1550	0	5	-23	-3	70	23

^a All cabling is duplex type unless specified otherwise.

^b Typical.

^c All optical power numbers are listed as dBm averages.

^d Typical distance. The maximum segment length is greatly dependent on factors such as fiber quality, and the number of patches and splices. Consult a Siemens sales associates when determining maximum segment distances.

^e Operating temperature range of -25 to 85 °C (-13 to 185 °F).

5.6 Operating Environment

The RUGGEDCOM RSG2300 is rated to operate under the following environmental conditions.

Ambient Operating Temperature ^{ab}	-40 to 85°C (-40 to 185 °F)
Ambient Storage Temperature	-40 to 85°C (-40 to 185 °F)
Ambient Relative Humidity ^c	5% to 95%

Maximum Altitude	2000 m (6562 ft)
-------------------------	------------------

^a Measured from a 30 cm (12 in) radius surrounding the center of the enclosure.

^b Operating temperature may vary based on the limitations of installed SFPs. Refer to the "RUGGEDCOM SFP Transceivers Catalog" for SFP temperature ratings.

^c Non-condensing

5.7 Mechanical Specifications

Weight	5.2 kg (11.5 lbs)
Ingress Protection	IP30
Enclosure	18 AWG Galvanized Steel

5.8 Dimension Drawings

Note

All dimensions are in millimeters, unless otherwise stated.

Note

Dimensional tolerances are in accordance with ISO 2768-mK, unless otherwise stated.

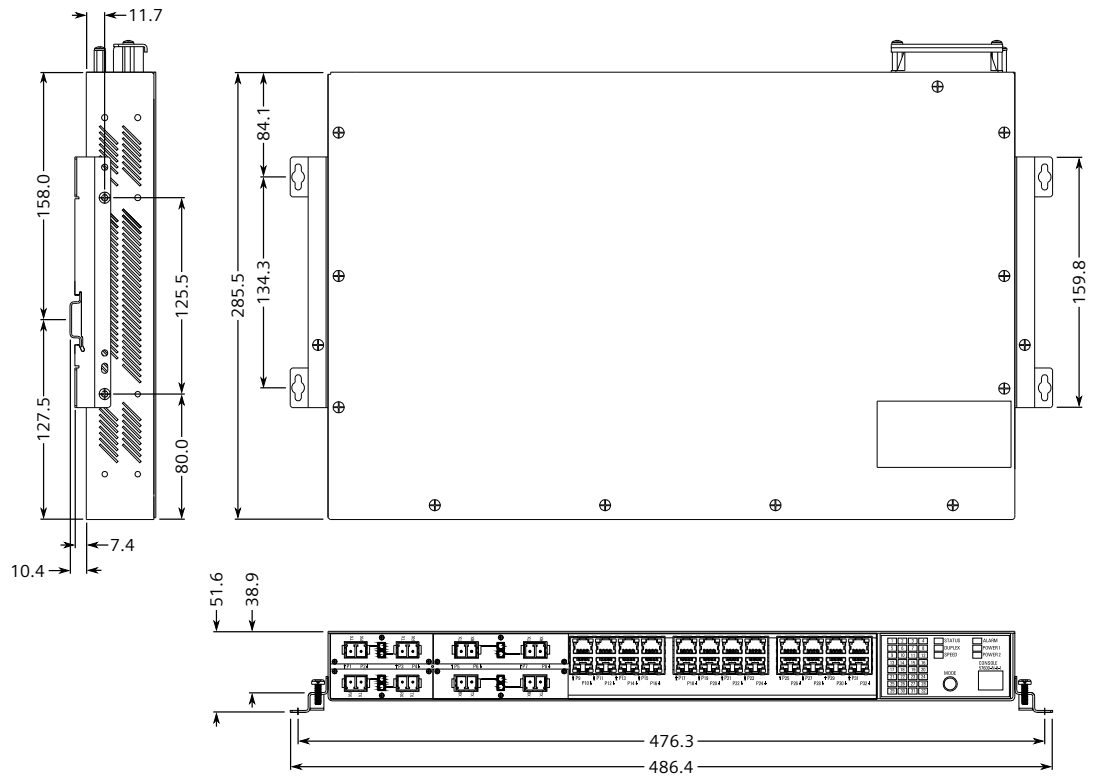

Figure 5.3 Panel and DIN Rail Mount Dimensions

Certification

The RUGGEDCOM RSG2300 device has been thoroughly tested to guarantee its conformance with recognized standards and has received approval from recognized regulatory agencies.

6.1 Approvals

This section details the standards to which the RUGGEDCOM RSG2300 complies.

Note

All relevant certificates and test reports are available on [Siemens Industry Online Support \[https://support.industry.siemens.com/cs/ww/en/ps/16008/cert\]](https://support.industry.siemens.com/cs/ww/en/ps/16008/cert).

6.1.1 UKCA

This device is certified for use in Great Britain and bears the United Kingdom Certified Assessed (UKCA) marking. The marking is printed on the body of the device.



6.1.2 CSA

This device meets the requirements of the following Canadian Standards Association (CSA) standards under certificate 16.70068356:

- **CAN/CSA-C22.2 No. 62368-1**
Information Technology Equipment – Safety – Part 1: General Requirements (Bi-National Standard, with UL 62368-1)
- **UL 62368-1**
Information Technology Equipment – Safety – Part 1: General Requirements

The device is marked with a CSA symbol that indicates compliance with both Canadian and U.S. requirements.



6.1.3 European Union (EU)

This device is declared by Siemens Canada Ltd. to comply with essential requirements and other relevant provisions of the following EU directives:

- **EN 62368-1**
Information Technology Equipment – Safety – Part 1: General Requirements
- **EN 61000-6-2**
Electromagnetic Compatibility (EMC) – Part 6-2: Generic Standards – Immunity for Industrial Environments
- **EN 60825-1**
Safety of Laser Products – Equipment Classification and Requirements
- **EN 63000**
Technical Documentation for the Assessment of Electrical and Electronic Products with Respect to the Restriction of Hazardous Substances
- **CISPR 32/EN 55032**
Electromagnetic Compatibility of Multimedia Equipment. Emission Requirements.

The device is marked with a CE symbol and can be used throughout the European community.



6.1.4 FCC

This device has been tested and found to comply with the limits for a Class A digital device, pursuant to Part 15 of the FCC Rules. These limits are designed to provide reasonable protection against harmful interference when the equipment is operated in a commercial environment.

This device generates, uses and can radiate radio frequency energy and, if not installed and used in accordance with the instruction manual, may cause harmful interference to radio communications. Operation of this equipment in a residential area is likely to cause harmful interference in which case users will be required to correct the interference at their own expense.

 **NOTICE**

Changes or modifications not expressly approved by the party responsible for compliance could void the user's authority to operate this device.

6.1.5 FDA/CDRH

This device meets the requirements of the following U.S. Food and Drug Administration (FDA) standard:

- Title 21 Code of Federal Regulations (CFR) – Chapter I – Sub-chapter J – Radiological Health

6.1.6 ISED

This device is declared by Siemens Canada Ltd. to meet the requirements of the following ISED (Innovation Science and Economic Development Canada) standard:

- CAN ICES-3 (A)/NMB-3 (A)

6.1.7 ISO

This device was designed and manufactured using a certified ISO (International Organization for Standardization) quality program that adheres to the following standard:

- **ISO 9001:2015**
Quality management systems – Requirements

6.1.8 ACMA

This device meets the requirements of the following Australian Communications and Media Authority (ACMA) standards under certificate ABN 98 004 347 880:

- Radiocommunications (Compliance Labeling – Devices) Notice 2014 made under section 182 of the Radiocommunications Act 1992
- Radiocommunications Labeling (Electromagnetic Compatibility) Notice 2017 made under section 182 of the Radiocommunications Act 1992
- Radiocommunications (Compliance Labeling – Electromagnetic Radiation) Notice 2014 made under section 182 of the Radiocommunications Act 1992
- Telecommunications (Labeling Notice for Customer Equipment and Customer Cabling) Instrument 2015 made under section 407 of the Telecommunication Act 1997

The device is marked with an RCM symbol to indicate compliance when sold in the Australian region.



A copy of the Declaration of Conformity is available via Siemens Industry Online Support at <https://support.industry.siemens.com/cs/ww/en/view/89855782>.

6.1.9 RoHS

This device is declared by Siemens Canada Ltd. to meet the requirements of the following RoHS (Restriction of Hazardous Substances) directives for the restricted use of certain hazardous substances in electrical and electronic equipment:

- **EU RoHS Directives (EU) 2011/65 and (EU) 2015/863**
European Directive for Restriction of Hazardous Substances
- **China RoHS (relating to SJ/T 11364)**
Management Methods for the Restriction of the Use of Hazardous Substances in Electrical and Electronic Products

Declarations of conformity for each directive are available online via [Siemens Industry Online Support \[https://support.industry.siemens.com/\]>](https://support.industry.siemens.com/).

6.1.10 Other Approvals

This device meets the requirements of the following additional standards:

- **IEEE 1613**
IEEE Standard Environmental and Testing Requirements for Communications Networking Devices in Electric Power Substations
- **IEC 61000-6-2**
Electromagnetic Compatibility (EMC) – Part 6-2: Generic Standards – Immunity for Industrial Environments
- **IEC 61850-3**
Communication Networks and Systems in Substations – Part 3: General Requirements

6.2 EMC and Environmental Type Tests

The RUGGEDCOM RSG2300 has passed the following Electromagnetic Compatibility (EMC) and environmental tests.

EMC Type Tests per IEC 61850-3

Test	Description		Test Levels	Severity Levels
IEC 61000-4-2	ESD	Enclosure Contact	±8 kV	4
		Enclosure Air	±15 kV	
IEC 61000-4-3	Radiated RFI	Enclosure Ports	20 V/m	
IEC 61000-4-4	Burst (Fast Transient)	Signal Ports	±4 kV @ 2.5 kHz	4
		DC Power Ports	±4 kV	
		AC Power Ports		
		Earth Ground Ports ^a		
IEC 61000-4-5	Surge	Signal Ports	±4 kV Line-to-Ground, ±2 kV Line-to-Line	4
		DC Power Ports	±2 kV Line-to-Ground, ±1 kV Line-to-Line	3
		AC Power Ports	±4 kV Line-to-Ground, ±2 kV Line-to-Line	4
IEC 61000-4-6	Induced (Conducted) RFI	Signal Ports	10 V	3
		DC Power Ports		
		AC Power Ports		
		Earth Ground Ports ^a		
IEC 61000-4-8	Magnetic Field	Enclosure Ports	100 A/m Continuous 1000 A/m for 1 s	5
IEC 61000-4-11	Voltage Dips and Interrupts	AC Power Ports	30% for 1 period 60% for 50 periods 100% for 5 periods 100% for 50 periods	
IEC 61000-4-12	Damped Oscillatory	Signal Ports	2.5 kV Common	3
		DC Power Ports	1 kV Differential Mode @1 MHz	
		AC Power Ports		
IEC 61000-4-16	Mains Frequency Voltage	Signal Ports	30 V Continuous	4
		AC and DC Power Ports	300 V for 1s	
IEC 61000-4-17	Ripple on DC Power Supply	DC Power Ports	15%	3
IEC 61000-4-29	Voltage Dips and Interrupts	DC Power Ports	30% for 0.1 s 60% for 0.1 s 100% for 0.05 s	
IEC 60255-27	Dielectric Strength	Signal Ports	2 kV (Fail-Safe Relay Output)	
		DC Power Ports	2 kV	

6.2 EMC and Environmental Type Tests

Test	Description		Test Levels	Severity Levels
	HV Impulse	AC Power Ports	2 kV	
		Signal Ports	5 kV (Fail-Safe Relay Output)	
		DC Power Ports	5 kV	
		AC Power Ports		

^a Only applicable to functional earth connections separated from the safety earth connection.

EMC Immunity Type Tests per IEEE 1613

Note

RUGGEDCOM products meet Class 1 requirements for copper Ethernet configurations and Class 2 for fiber Ethernet configurations. Class 1 allows for temporary communication loss, while Class 2 requires error-free and interrupted communications.

Description		Test Levels
ESD	Enclosure Contact	±2 kV ±8 kV
	Enclosure Air	±15 kV
Radiated RFI	Enclosure Ports	35 V/m
Fast Transient	Signal Ports	4 kV @ 2.5 kHz
	DC Power Ports	4 kV
	AC Power Ports	4 kV
	Earth Ground Ports	4 kV
Oscillatory	Signal Ports	2.5 kV Common Mode @ 1 MHz
	DC Power Ports	2.5 kV Common 1 kV differential mode @ 1 MHz
	AC Power Ports	2.5 kV Common 1 kV differential mode @ 1 MHz
HV Impulse	Signal Ports	5 kV (Fail-Safe Relay Output)
	DC Power Ports	5 kV
	AC Power Ports	5 kV
Dielectric Strength	Signal Ports	2 kV
	DC Power Ports	2 kV
	AC Power Ports	2 kV
Damped Oscillatory Magnetic Field	Enclosure Ports	100 A/m

Environmental Type Tests

Test	Description		Test Levels
IEC 60068-2-1	Cold Temperature	Test Ad	-40 °C (-40 °F), 16 Hours

6.2 EMC and Environmental Type Tests

Test	Description		Test Levels
IEC 60068-2-2	Dry Heat	Test Bd	85 °C (185 °F), 16 Hours
IEC 60068-2-30	Humidity (Damp Heat, Cyclic)	Test Db	95% (Non-Condensing), 55 °C (131 °F), 6 Cycles
IEC 60068-2-6 IEC 60255-21-1	Vibration		2g @ 10-150 Hz, 2 hours per axis
IEC 60068-2-27 IEC 60255-21-2	Shock		30 g @ 11 ms

For more information

Siemens RUGGEDCOM

<https://www.siemens.com/ruggedcom>

Industry Online Support (service and support)

<https://support.industry.siemens.com>

Industry Mall

<https://mall.industry.siemens.com>

Siemens Canada Ltd.

Digital Industries

Process Automation

300 Applewood Crescent

Concord, Ontario, L4K 4E5

Canada

© 2023 Siemens Canada Ltd.

Subject to change